

# NF20

## Power factor controller



User's manual





### CAUTIONS:

1. High voltage !
  2. This controller may only be used indoor !
  3. Make sure that the discharge time set in controller matches capacitor discharge time !
-

**CONTENTS**

Section 1	General
Section 2	Mechanical Dimensions and panel cut out
Section 3	Installation And Connection Of The Controller
	3,1 Alarm Output / Error Messages
Section 4	Terminals
	4,1 Without Add on Card (Relay +Modbus)
	4,2 With Add on Card (Relay +Modbus)
	4,3 Nf20 6 RELAY model
	4,4 Nf20 12 RELAY model
Section 5	Front Screen
Section 6	Front Screen Capacitor Symbols
Section 7	Keyboard
Section 8	Display Of Various Electrical Parameters
Section 9	Display Operations
Section 10	Basic Settings

## Power Factor Controller

Section 11	Advanced Settings
	11,1 System Setup
	11,2 Manual Setup
	11,3 Alarm Setup
	11,4 Reset Values
	11,5 Modbus Setup
	11,6 Display Setup
	11,7 Change Password
Section 12	Service Mode
Section 13	Technical Data
Section 14	Factory Default Setting
Section 15	Operating Diagram
Section 16	Ordering codes

## **Section1 General**

The power factor controller is a modern control device of innovative design with a variety of functions.

It is designed for a measuring voltage of 30...550V (L-N) or (L-L) and a auxillary supply voltage of 110 to 550 VAC.

It features a user interface with a menu-driven display in plain text for maximum ease of operation. Straightforward symbols and alphanumeric displays combine maximum ease of handling with convenient presentation of results.

Display of various grid parameters, storage of various values and a test run option make it easy to analyse errors and monitor the system.

Main features:

- 4/6/8 switching outputs , 6/8/12 switching outputs

- Programable individual banks kvar value

- Complete menu-guided operation and display

- Illuminated graphic display with 2 x 16 characters

- Four-quadrant operation

- Display of various line parameters (V, I, F, Q, P, S...)

- Monitoring of the individual capacitor power values

- Storage of maximum line-parameter and switching-operation values as well as of the turn-on times of individual capacitor contactors

- Manual / automatic operation

- Programming of fixed stages and the option of skipping individual outputs

- Error detection for various states and interference-message output

- Test run of NF20 system with error analysis

---

Recall function of recorded values  
 True RMS measurement upto 31<sup>st</sup> harmonics  
 Display of individual voltage and current harmonics in % upto 31<sup>st</sup>  
 Display of voltage and current total harmonics distortion  
 Display and monitoring of temperature  
 Potential free contact alarm output , rtc (Optional)

### NF20 96 Model

NF20	4 relays outputs, 1 alarm relay
	6 relay outputs, 1 alarm relay
	8 relays outputs, 1 alarm relay
Option RS485	Optional additional Interface Module RS 485 output
Option RTC	Optional additional module Real Time Clock.

### NF20 144 Model

NF20	6 relays outputs, 1 alarm relay
	8 relay outputs, 1 alarm relay
	12 relays outputs, 1 alarm relay
Option RS485	Optional Interface RS 485 output
Option RTC	Optional Real Time Clock.

## **Section 2 Mechanical Dimensions :**

### 96 model Without Add On card (Relay + Modbus)

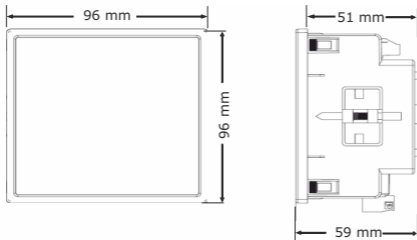

### NF20 96 model With Add On card (Relay + Modbus)

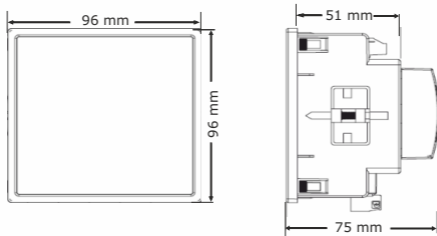





### Panel Cutout for NF20 96 size model

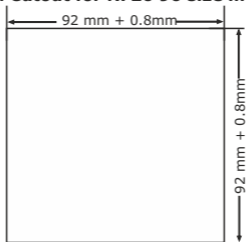

### Optional Pluggable Module (Relay + Modbus)

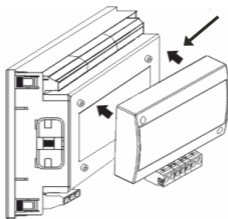

Insert The ADD on assembly here and fit the assembly with screws.

## Section 2 Mechanical Dimensions : 144 size model

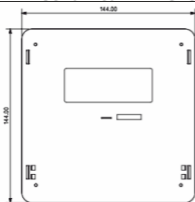

FRONT VIEW

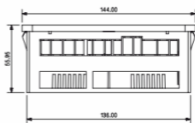

SIDE VIEW

### Panel Cutout

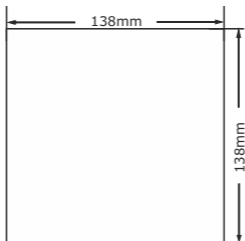

### **Section 3 Installation and connection of the controller**

The controller is designed to be incorporated into the front panel of a NF20-cabinet. It requires a panel cutout of 92 x 92 mm for 96 mm Model and 138 x 138 for 144 size model. The controller is inserted from the front and it gets fitted into panel with help of self clicking & if required swivel screw can be used. The controller should be installed by qualified technicians and must be operated in accordance with the specified safety regulations.

Mounting of the controller is featured with easy "Clip- in" mounting. Push the meter in panel slot, it will click fit into panel with the four integral retention clips on two sides of meter. If required, additional support is provided with swivel screws as shown in Fig. 1 for NF20 96 Model. same is applicable for NF20 144 MODEL

Before the controller is connected up, all leads and cables must be checked to ensure that no current is flowing through them. Care should be taken to ensure that the measuring voltage and current are in the correct phase position. The connection should be set up as shown in Fig. 2. The specified safety regulations must be observed.

The measuring voltage may lie in the range from 30 - 550 VAC and can be connected between L - N or between L - L.

The auxiliary supply voltage is 110 to 550 VAC and can be connected between L - N or L -L (depending of the grid).

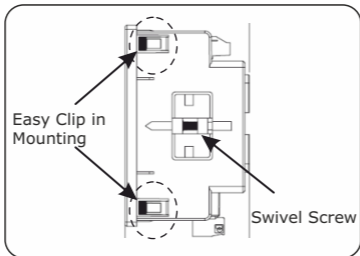

Fig 1: Installation

### **3.1 Alarm output / error messages**

The alarm contact is open in normal operation and closed in the event of a fault. The relevant fault is simultaneously shown on the display in plain text. The following fault messages are displayed:

UNDervOLTAGE	Display and relay output
OVERVOLTAGE	Display and relay output
UNDER FREQUENCY	Display and relay output
OVER FREQUENCY	Display and relay output
UNDER CURRENT	Display and relay output
OVER CURRENT	Display and relay output
VOLTAGE HARMONICS	Display and relay output
CURRENT HARMONICS	Display and relay output
OVER TEMPERATURE	Display and relay output
OUT OF BANK	Display and relay output
OVER COMPENSATION	Display and relay output

Fig. 2: NF20 96 Model Electrical Connection

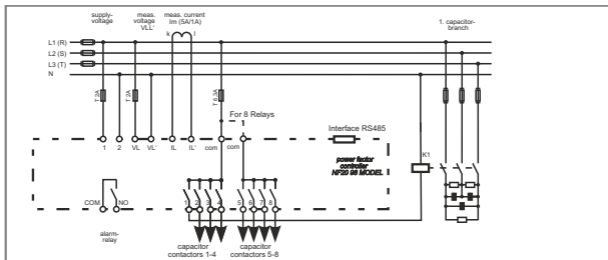

NF20 144 Model Electrical Connection

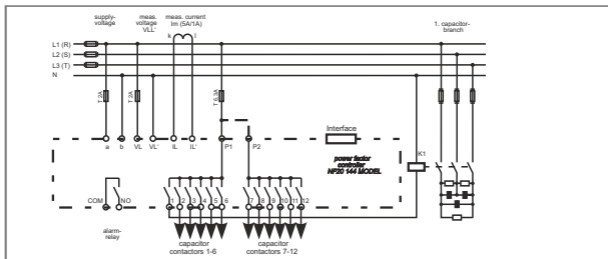

## Section 4 Rear side Terminals

### 4.1 Without Add on Card (Relay + Modbus)

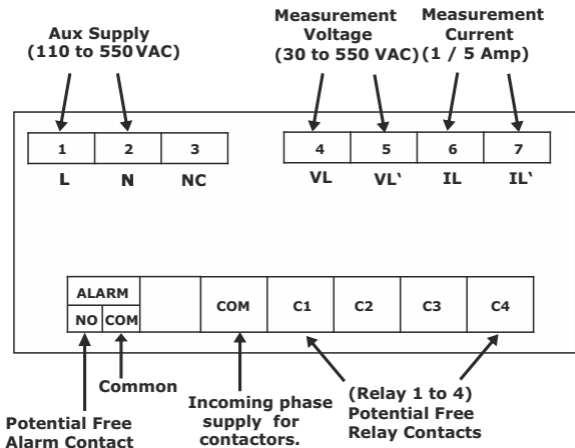

## 4.2 With Add on Card (Relay + Modbus)

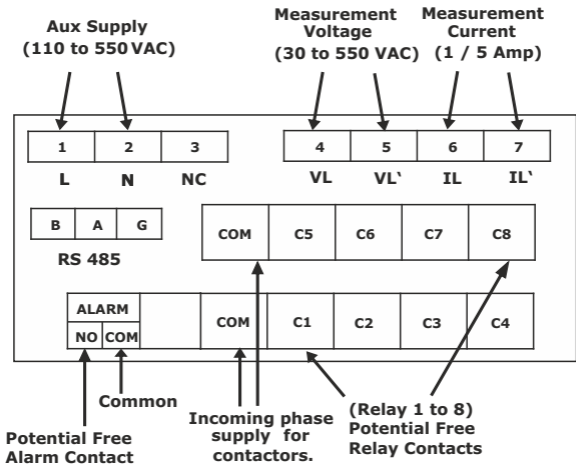

## Section 4 NF20 144 Terminals

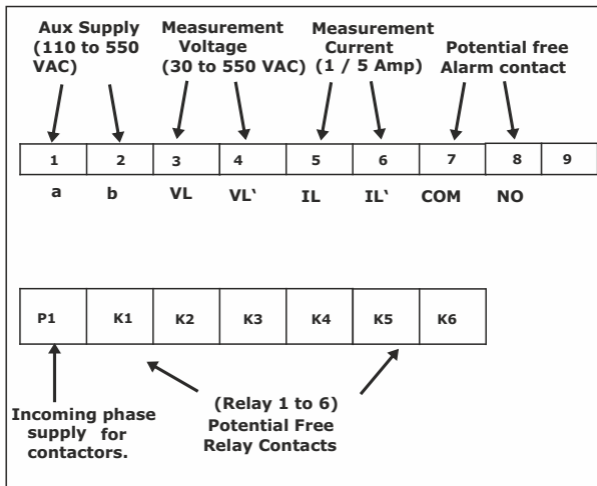



## Section 4 NF20 144 Terminals

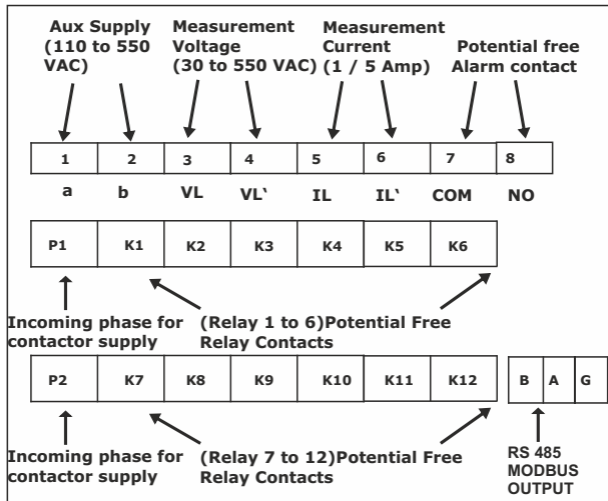

## Section 5 Front Screen

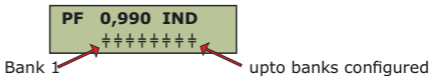

First line indicates the PF value, inductive / capacitive PF.

"PF = 0.999" indicates the overall PF of the system.

"IND" or "CAP" indicates inductive or capacitive respectively.

**For NF20 96 Model max bank are 8 and for NF20 144 Model max banks are 12**

Meter toggles between PF screen, Fault status screen.

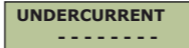

Fault status screen represent one out of following status :

UNDERVOLTAGE

OVERVOLTAGE

UNDER FREQUENCY

OVER FREQUENCY

UNDER CURRENT

OVER CURRENT

OVER HARMONICS VOLTAGE

OVER HARMONICS CURRENT

OVER TEMPERATURE

OUT OF BANK

OVER COMPENSATION

LOW Batt (\*Only applicable for RTC model)

If any one out of above mentioned faults occurred, Connected banks will disconnect one by one in a interval of 1sec and enters into discharging state.

## **Section 6 Front Screen capacitor symbols**

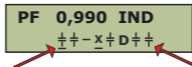

Bank 1

Upto Banks configured

Example of a typical LCD display screen is shown below:

Meaning of this screen contents:

Total no. of banks connected are 8.

Power Factor at Load sensing CT is 0.990 IND (Inductive). ('CAP' defines Capacitive).

Total number of banks that are operational are Eight.

Bank no. 1 is declared as fixed and is in ON condition.

Bank no. 2 is in ON condition (Auto mode).

Bank no. 3 is in Auto mode, off state. Ready to be switch ON.

Bank no. 4 is declared as fixed and faulty.

Bank no. 5 is in ON condition (Auto mode).

Bank no. 6 is in discharging state.

Bank no. 7,8 is in ON condition (Auto mode).

## **Section 7 Keyboard**

Keyboard with soft touch keys are provided on the front fascia of the controller. The various keys are:-



MENU Key. Pressing menu key will enter into main menu OR to exit from sub menu.



UP Key. Used to scroll up the menu screen; increment values when entering numbers.



DOWN Key. Used to scroll down the menu screen; decrement values when entering numbers.



ENTER key. Used for entering a submenu or for setting up values.

## Section 8 Display of various electrical parameters:

Values of various electrical parameters can be viewed by using UP / Down keys.

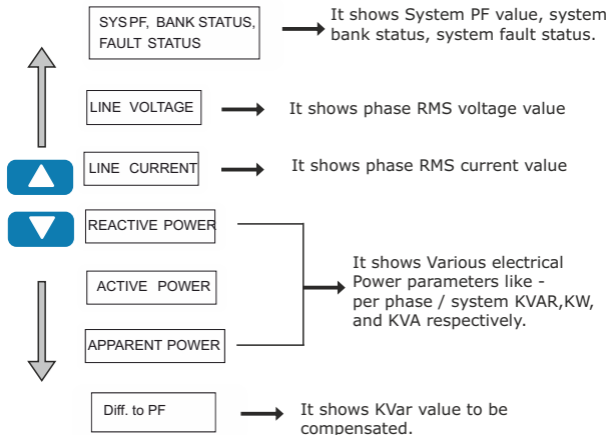

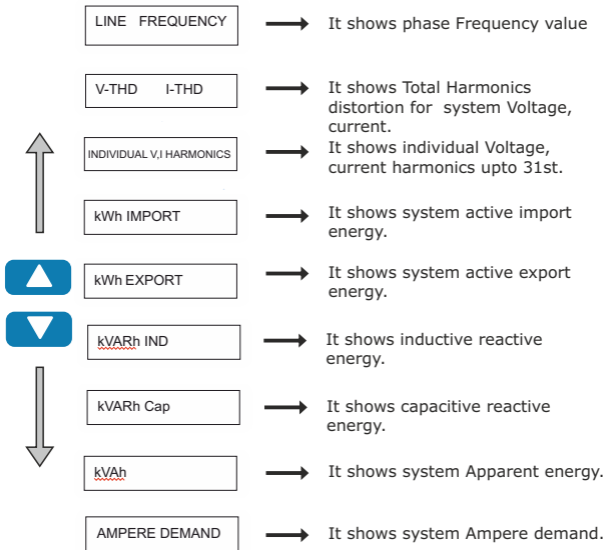

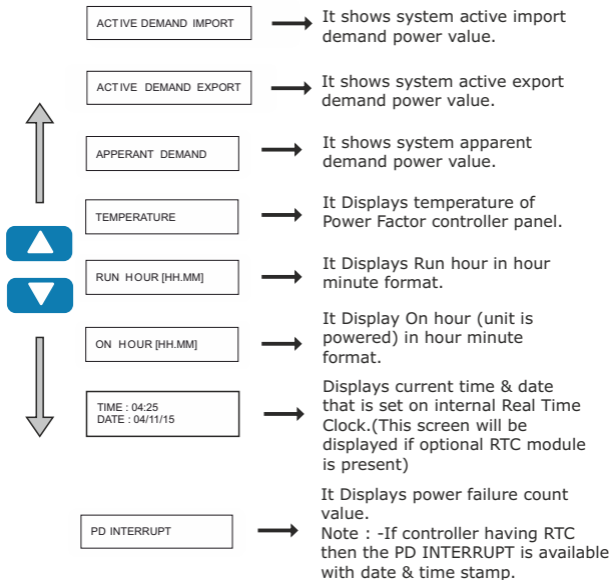

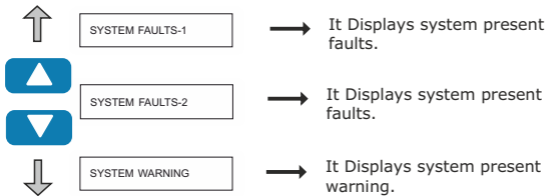

## **Section 9 Display Operations**

There are three main menus namely Basic Setting, Advanced Setting, Service Modes.

Press Menu key to enter into main menus from display parameters.

Press Up / down key to scroll through main menus.

Press Enter key to enter into submenus.



## **Section 10 BASIC SETTINGS**

Press ENTER key to enter into Basic setting.

ENTER PASSWORD

ENTER PASSWORD : Password protection can be enabled to prevent unauthorised access to basic setting's sub-menus, by default password is set to 0000.

APFC allows user to set password in range 0000 to 9999. Password protection is enabled by selecting a four digit number other than 0000.



### **Password Setting:**

To change password please refer section 11.7

CT PRIMARY

CT PRIMARY : This parameter allows user to set Current transformer's primary value. Value is settable from 0001 to 9999 Amp.



Press ENTER key to edit CT PRIMARY value.

Pressing  or  key will increment or decrement digit value. Then pressing ENTER key will advance to next digit & confirm newly changed values.

CT SECONDARY

CT SECONDARY : This parameter allows user to set Current transformer's secondary value. Value can be set as 1 or 5 Amp.

Press ENTER key to edit CT SECONDARY value.

Pressing  or  key will increment or decrement digit value. Then press ENTER key to confirm newly changed values.

SYS NOM VOLTAGE

SYSTEM NOMINAL VOLTAGE : This is the system rated voltage with respect to which the fault limits are defined. Value is settable from 50 to 550 VAC. Press ENTER key to edit system nominal value. Pressing ▲ or ▼ key will increment or decrement digit value. Then pressing ENTER key will advance to next digit & confirm newly changed values.

BANKS IN USE

BANKS IN USE : user can set banks from 1 to 4. If Add on card with 4 relays are attached user can set banks from 1 to 8 ( NF20 96 Model). for NF20 144 Model it can be 1 to 12. Press ENTER key to edit banks in use. Pressing ▲ or ▼ key will increment or decrement digit value. Then pressing ENTER key will confirm newly changed values.

BANK1 KVAR VALUE

BANK KVAR VALUES : user can program bank kvar values in range 1 to 255 kVAR. Increments in steps of 0.5 kVAR. kVAR value with decimal digit is possible.

Press ENTER key to edit bank kVAR values. Pressing ▲ or ▼ key will increment or decrement digit value. Then pressing ENTER key will advance to next digit & confirm newly changed values.

BANK(n) KVAR VALUE

Note : n = 4, if APFC with 4 relay output.  
n = 6, if APFC with 6 relay output.  
n = 8, if APFC with 8 relay output.  
n = 12, if APFC with 12 relay output.

## **Section 11 ADVANCED SETTINGS**

Press ENTER key to enter into Advance setting.

ENTER PASSWORD

ENTER PASSWORD : Password protection can be enabled to prevent unauthorised access to advanced setting's sub-menus, by default password is set to 0001.

APFC allows user to set password in range 0000 to 9999. Password protection is enabled by selecting a four digit number other than 0000.



### **Password Setting:**

To change password please refer section 11.7

### **Section 11.1 : SYSTEM SETUP**

This menu allows user to set one out of several system related setup parameters.



SYSTEM SETUP

Press ENTER key to enter into system setup sub menus. Pressing  or  key will scroll through submenus.

**TARGET PF** :This parameter is the target power factor of system. Value is settable from 0.8 INDUCTIVE to 0.8 CAPACITIVE.

TARGET PF



Press ENTER key to edit target PF.

Pressing  or  key will increment or decrement digit value. Then pressing ENTER key will advance to next digit & confirm newly changed values.

SWITCH-IN-TIME

**SWITCH IN TIME** :This parameter is the SWITCH-IN time of individual capacitor bank. Switch in time Value is settable from 10 to 1800 Sec.

Press ENTER key to edit switch in time value.

Pressing  or  key will increment or decrement digit value resp. Then pressing ENTER key will advance to next digit & confirm newly changed values.

SWITCH-OFF-TIME

SWITCH OFF TIME :This parameter is the SWITCH-OFF time of individual capacitor bank. Switch off time Value is settable from 10 to 1800 Sec.

Press ENTER key to edit Switch off time value. Pressing ▲ or ▼ key will increment or decrement digit value resp. Then pressing ENTER key will advance to next digit & confirm newly changed values.

DISCHARGE TIME

DISCHARGE TIME :This parameter is the discharge time of individual capacitor bank. discharge time Value is settable from 60 to 1800 Sec.

Press ENTER key to edit discharge time value. Pressing ▲ or ▼ key will increment or decrement digit value resp. Then pressing ENTER key will advance to next digit & confirm newly changed values.

THRESHOLD

THRESHOLD : Threshold for switching ON / OFF next stage. It should not be change in normal case!

Threshold value is editable in range 30 to 100%. Press ENTER key to edit threshold value. Pressing ▲ or ▼ key will increment or decrement digit value resp. Then pressing ENTER key will advance to next digit & confirm newly changed values.

SWITCHING OPERATION WARNING COUNT : After an output has performed this number of switching operations a warning message is displayed. switching operation warning count is editable in range 10000 to 255000. warning will get disappear if user resets switching operation count.

SWITCHING OPERATION  
WARNING COUNT

Press ENTER key to edit switching operation count. Pressing ▲ or ▼ key will increment or decrement digit value resp. Then pressing ENTER key will advance to next digit & confirm newly changed values.

Capacitor Health Check : The kvar of the particular capacitor bank is calculated during each switching operation and compared with stage output of capacitor. If the result varies by 80% of nominal value for a particular bank warning will be displayed & if it goes below 70% of nominal value that particular bank will get block. user can enable or disable this feature. The number of attempts for checking bank value are programable, refer "cap test attempt" count.

CAP HEALTH CHECK

Press ENTER key to edit cap health check.  
Press ▲ or ▼ key to get available options (yes /no) resp. Then pressing ENTER key will confirm newly changed options.

#### CAPACITOR TEST ATTEMPTS COUNT :

This parameter is programable in range 5 to 9. when at least this number of successive measurement is resulted in fault in the capacitor power, Capacitor fault message will appear on display.

CAPACITOR TEST  
ATTEMPTS COUNT

Press ENTER key to edit capacitor test attempt count. Pressing ▲ or ▼ key will increment or decrement digit value resp. Then pressing ENTER key will advance to next digit & confirm newly changed values.

#### SYSTEM FREQUENCY :

This parameter is settable as 50 or 60 Hz.

SYSTEM FREQUENCY

Press ENTER key to edit parameter. Pressing ▲ or ▼ key will increment or decrement digit value resp. Then pressing ENTER key will advance to next digit & confirm newly changed values.

SYSTEM TYPE

### SYSTEM TYPE :

This parameter is settable as 1 phase or 3 phase.

Press ENTER key to edit parameter.

Press ▲ or ▼ key to get available options (1PH /3PH) resp. Then pressing ENTER key will confirm newly changed option.

INPUT PHASE CURRENT

### INPUT PHASE CURRENT / VOLTAGE :

This parameters are used for phase correction between voltage and current in the measuring system.

INPUT PHASE VOLTAGE

This parameter is user programable.

Refer following table for editing parameters

PHASE CURRENT	PHASE VOLTAGE
IL1	L1 - N - 0°
IL1	L1 - L2 - 30°
II1 ( k <- > I )	L2 - N - 60°
IL1	L3 - L2 - 90°
IL1	L3 - N - 120°
IL1	L3 - L1 - 150°
II1 ( k <- > I )	L1 - N - 180°
II1 ( k <- > I )	L1 - L2 - 210°
IL1	L1 - N - 240°
II1 ( k <- > I )	L2 - L3 - 270°
II1 ( k <- > I )	L3 - N - 300°
II1 ( k <- > I )	L3 - L1 - 330°



PHASE CURRENT	PHASE VOLTAGE
IL2	L2 - N - 0°
IL2	L2 - L3 - 30°
II2 ( k <- > I )	L3 - N - 60°
IL2	L1 - L3 - 90°
IL2	L1 - N - 120°
IL2	L1 - L2 - 150°
II2 ( k <- > I )	L2 - N - 180°
II2 ( k <- > I )	L2 - L3 - 210°
IL2	L3 - N - 240°
II2 ( k <- > I )	L3 - L1 - 270°
II2 ( k <- > I )	L1 - N - 300°
II2 ( k <- > I )	L1 - L2 - 330°



PHASE CURRENT	PHASE VOLTAGE
IL3	L3 - N - 0°
IL3	L3 - L1 - 30°
II3 ( k <- > I )	L1 - N - 60°
IL3	L2 - L1 - 90°
IL3	L2 - N - 120°
IL3	L2 - L3 - 150°
II3 ( k <- > I )	L3 - N - 180°
II3 ( k <- > I )	L3 - L1 - 210°
IL3	L1 - N - 240°
II3 ( k <- > I )	L1 - L2 - 270°
II3 ( k <- > I )	L2 - N - 300°
II3 ( k <- > I )	L2 - L3 - 330°

ENERGY DEMAND  
INTEGRATION TIME

ENERGY DEMAND INTEGRATION TIME :

This parameter is used to set the period over which current and power readings are to be integrated. The Unit of displayed values is minutes. time is settable as 8,15,20,30 min resp.

Press ENTER key to edit parameter.



Pressing  or  key will increment or decrement digit value resp. Then pressing ENTER key will advance to next digit & confirm newly changed values.

ENERGY UPDATE RATE

ENERGY UPDATE RATE :

This parameter allows user to enter energy update rate in min. Time is settable in range 1 to 60 min resp.

Press ENTER key to edit parameter.

Pressing  or  key will increment or decrement digit value resp. Then pressing ENTER key will advance to next digit & confirm newly changed values.

ENERGY UNIT

ENERGY UNIT :

This parameter allows user to set energy in terms of Wh / kWh / MWh as per the requirement. Same is applicable to all types of energy.

Press ENTER key to edit parameter.  
Pressing ▲ or ▼ key will scroll between the available options. Then pressing ENTER key will confirm the newly selected option.

ENERGY OVERFLOW  
COUNT

#### ENERGY OVERFLOW COUNT :

This parameter is used for setting maximum energy count after which energy will roll over to zero depending on setting of Wh, KWh & MWh. Count is settable in range 7 to 9.

Press ENTER key to edit parameter.  
Pressing ▲ or ▼ key will increment or decrement digit value resp. Then pressing ENTER key will advance to next digit & confirm newly changed values.

#### RTC DATE, TIME

Date: Allows user to set date.

Time: Allows user to set the time.

RTC DATE , TIME

Press ENTER key to edit parameter.  
Pressing ▲ or ▼ key will increment or decrement digit value resp. Then pressing ENTER key will advance to next digit & confirm newly changed values.

**Note:** (optional menu displayed when RTC module is present)

DEFAULT SYSTEM VALUES

DEFAULT SYSTEM VALUES :

This menu allows user to reset NF20 to factory default setting.(Refer section 14 )

Press ENTER key to edit parameter.

Press ▲ or ▼ key to get available options. Then press ENTER key to confirm newly changed option. During factory reset meter will display "WAIT" message on second row then NF20 will reset to factory default settings.

**Note :** - Resetting to factory default setting APFC will initialize Energy, Demand counters and resets Min / max values.

MAX SWITCH POWER

MAX SWITCH POWER :

This menu allows user to set maximum capacitor bank kVAr switching value.

The settable range is from minimum set capacitor bank value upto the sum of total capacitor banks values.

Increments in steps of minimum capacitor bank value.

Press ENTER key to edit parameter.

Press ▲ or ▼ key to increments OR decrements max switching power in steps of minimum bank kVAr value. Then press ENTER key to confirm newly changed max switching power.

MANUAL SETUP

**Section 11.2 :MANUAL SETUP :**

This menu allows user to test or set the bank operating mode.

**BANK ON / OFF MANUALLY :**

This menu allows user to ON / OFF banks set in Auto mode only.

Press ENTER key to ON/OFF Bank manually.

Press ▲ or ▼ key to get available options as ON / OFF. Then press ENTER to ON / OFF bank manually.

**Note :** - APFC allows to ON / OFF Banks set in Auto mode only. If fault is present APFC does not allow to ON/OFF Banks manually. On exit from manual mode all the banks enter into Auto mode.

**BANKS FUNCTION :**

This parameter allows to set individual bank operating mode.

Press ENTER key to edit parameter.

Press ▲ or ▼ key to get available options as AUTO / FIXED / OFF. Then press ENTER to confirm individual bank operating mode.

Auto : Automatic Operation

It is displayed as capacitor symbol if connected.

Fixed : - It is displayed as capacitor symbol with underline. Fixed Capacitor Banks are continuously connected except in fault condition.

Off : - It is displayed as cross symbol. The capacitor banks are permanently disconnected.



BANK ON / OFF  
( MANUALLY )

BANKS FUNCTIONS AS  
AUTO / FIXED / FAULTY

ALARM SETUP



**Section 11.3 :ALARM SETUP :**

This menu allows user to set one out of several alarm related parameters.

Press ENTER key to enter into alarm setup sub menus. Pressing  or  key will scroll through submenus.



UNDER -VOLTAGE

UNDER VOLTAGE : It is for Under voltage protection when phase voltage goes below the set threshold value.

Press ENTER key to enter into under voltage sub setup. Pressing  or  key will scroll through submenus.



TRIGGER VALUE  
( 75 TO 99 % )

TRIGGER VALUE : Value is settable from 75 to 90% of system nominal voltage value.

Press ENTER key to edit trigger value. Pressing  or  key will increment or decrement digit value. Then pressing ENTER key will advance to next digit & confirm newly changed values.

RELAY ACTIVATION

RELAY ACTIVATION : APFC unit allows to activate / deactivate assigned relay.



Press ENTER key to edit option. Press  or  key to get available options. Then press ENTER key to confirm newly changed option.

**Note 1:** - If fault occurs APFC will Switch off all banks including fixed banks one after the other with a delay of 1sec between the banks when fault occurs.

**Note 2:** - Relay will reset at 3% of voltage nominal value plus trip value.  
Reset point is factory set, not editable.



OVER VOLTAGE

OVER VOLTAGE : It is for over voltage protection against over voltage condition in phase.

Press ENTER key to enter into over voltage sub setup.  
Pressing  or  key will scroll through submenus.



TRIGGER VALUE : Value is settable from 105 to 115% of system nominal voltage value.

TRIGGER VALUE  
( 105 TO 115 % )

Press ENTER key to edit trigger value.  
Pressing  or  key will increment or decrement digit value. Then pressing ENTER key will advance to next digit & confirm newly changed values.

RELAY ACTIVATION



RELAY ACTIVATION : APFC unit allows to activate / deactivate assigned relay.

Press ENTER key to edit option.  
Press  or  key to get available options. Then press ENTER key to confirm newly changed option.

**Note :** - 1. If fault occurs APFC will Switch off all banks including fixed banks one after the other with a delay of 1sec between the banks when fault occurs.  
2. Relay will reset at 2% of voltage nominal value minus trip value. Reset point is factory set, not editable.

FREQUENCY FAULT

FREQUENCY FAULT : It is for frequency protection against frequency condition in phase.



Press ENTER key to enter into under frequency sub setup. Pressing  or  key will scroll through submenus.

TRIGGER VALUE : Value is settable from 2 to 10% of system frequency value.

TRIGGER VALUE

( 2 - 10 % )



Press ENTER key to edit trigger value.

Pressing  or  key will increment or decrement digit value. Then pressing ENTER key will advance to next digit & confirm newly changed values.

RELAY ACTIVATION

RELAY ACTIVATION : APFC unit allows to activate / deactivate assigned relay.

Press ENTER key to edit option.

Press  or  key to get available options. Then press ENTER key to confirm newly changed option.



**Note : -**

1. Frequency fault will occur at nominal frequency minus or plus of trigger point of nominal frequency.
  1. If fault occurs APFC will Switch off all banks including fixed banks one after the other with a delay of 1sec between the banks when fault occurs.
  2. Relay will reset at 1% of Nominal frequency value plus OR minus trip value resp. Reset point is factory set, not editable.
-



UNDER CURRENT



UNDER CURRENT : It is for under current protection against under current condition in phase.

Press ENTER key to enter into under current sub setup. Pressing  or  key will scroll through submenus.

TRIGGER VALUE : Value is settable from 1 to 3% of CT Primary. For example if CT ratio is 500/1A & trigger value is set as 1%, then under current fault will activate if load current falls below 1% of CT Primary.



TRIGGER VALUE

(1 - 3 %)

Press ENTER key to edit trigger value. Pressing  or  key will increment or decrement digit value. Then pressing ENTER key will advance to next digit & confirm newly changed values.

RELAY ACTIVATION



RELAY ACTIVATION : APFC unit allows to activate / deactivate assigned relay.

Press ENTER key to edit option. Press  or  key to get available options. Then press ENTER key to confirm newly changed option.

**Note** : - 1. If fault occurs APFC will Switch off all banks including fixed banks one after the other with a delay of 1sec between the banks when fault occurs.  
2. Relay will reset at Trip value plus 1% of CT Primary. Reset point is factory set, not editable.

OVER CURRENT



OVER CURRENT : It is for over current protection against over current condition in phase.

Press ENTER key to enter into over current sub setup.  
Pressing  or  key will scroll through submenus.

TRIGGER VALUE : Value is settable from 60 to 120%. For example if CT ratio is 500/1A & trigger value is set as 110%, then Over current fault will activate if load current exceeds 550A.



TRIGGER VALUE

( 60 - 120 % )

Press ENTER key to edit trigger value.  
Pressing  or  key will increment or decrement digit value. Then pressing ENTER key will advance to next digit & confirm newly changed values.

RELAYACTIVATION



RELAY ACTIVATION : APFC unit allows to activate / deactivate assigned relay.

Press ENTER key to edit option.  
Press  or  key to get available options. Then press ENTER key to confirm newly changed option.

**Note** : - 1. If fault occurs APFC will Switch off all banks including fixed banks one after the other with a delay of 1sec between the banks when fault occurs.  
2. Relay will reset at Trip value minus 1% of CT Primary.  
Reset point is factory set, not editable.

VOLTAGE THD



VOLTAGE THD : When voltage THD is more than set limit then PF controller will operate relay

Press ENTER key to enter into voltage THD sub setup. Pressing  or  key will scroll through submenus.

TRIGGER VALUE



( 1 - 25 % )

TRIGGER VALUE : Value is settable from 1 to 25%.

Press ENTER key to edit trigger value. Pressing  or  key will increment or decrement digit value. Then pressing ENTER key will advance to next digit & confirm newly changed values.

RELAY ACTIVATION



RELAY ACTIVATION : APFC unit allows to activate / deactivate assigned relay.

Press ENTER key to edit option. Press  or  key to get available options. Then press ENTER key to confirm newly changed option.

**Note** : - 1. If fault occurs APFC will Switch off all banks including fixed banks one after the other with a delay of 1sec between the banks when fault occurs.  
2. Relay will reset at set trigger value of voltage THD minus 5%.  
Reset point is factory set, not editable.



CURRENT THD

CURRENT THD : When current THD is more than set limit then PF controller will operate relay

Press ENTER key to enter into current THD sub setup. Pressing  or  key will scroll through submenus.



TRIGGER VALUE  
( 1 - 99 % )

TRIGGER VALUE : Value is settable from 1 to 99%.

Press ENTER key to edit trigger value. Pressing  or  key will increment or decrement digit value. Then pressing ENTER key will advance to next digit & confirm newly changed values.

RELAY ACTIVATION

RELAY ACTIVATION : APFC allows to activate / deactivate assigned relay.

Press ENTER key to edit option. Press  or  key to get available options. Then press ENTER key to confirm newly changed option.

**Note** : - 1. If fault occurs APFC will Switch off all banks including fixed banks one after the other with a delay of 1sec between the banks when fault occurs.  
2. Relay will reset at set current THD minus 5%.  
Reset point is factory set, not editable.

## TEMPERATURE

Temperature : When cabinet temperature exceeds above the 55 deg celsius APFC displays warning message and if temperature exceeds above 60 deg celsius APFC disconnects all the capacitor banks and activates the relay if enabled.

## RELAY ACTIVATION

RELAY ACTIVATION : APFC allows to activate / deactivate assigned relay.

Press ENTER key to edit option.

Press ▲ or ▼ key to get available options. Then press ENTER key to confirm newly changed option.

**Note** : - 1. If fault occurs APFC will Switch off all banks including fixed banks one after the other with a delay of 1sec between the banks when fault occurs.

2. When temperature regains below the 55 deg celsius the alarm relay gets deactivated and banks switching takes as per requirement

3. The temperature limit of 55 and 60 deg celsius is factory set and not editable.

OVER COMPENSATION

OVER COMPENSATION : In Auto mode if all banks are ON (except Fixed banks) and if Diff. to PF exceeds threshold of lower bank kvar value APFC will activate relay if enabled.



Press ENTER key to enter into over compensation sub setup.

Pressing  or  key will scroll through submenus.

RELAY ACTIVATION

RELAY ACTIVATION : APFC allows to activate / deactivate assigned relay.

Press ENTER key to edit option.

Press  or  key to get available options. Then press ENTER key to confirm newly changed option.

**Note** : - 1. Relay will reset if Diff. to PF goes below threshold of lower bank kvar value.

Out Of Banks

OUT OF BANKS : In Auto mode if all banks are ON and still target PF is not achieved APFC will operate relay if activated.

Press ENTER key to enter into OUT OF BANK sub setup.

Pressing  or  key will scroll through submenus.

RELAY ACTIVATION

RELAY ACTIVATION : APFC allows user to activate / deactivate assigned relay.

Press ENTER key to edit option.

Press ▲ or ▼ key to get available options. Then press ENTER key to confirm newly changed option.

**Note :** - Relay will reset if target PF is achieved.

BATT. LOW FAULT

BATT. LOW FAULT : - (\* Applicable for RTC module.)

If the internal Lithium coin Battery Voltage drops down, APFC will show "BAT" (low RTC battery) message on the system warning screen (Display Parameters) until the battery is replaced by a new healthy battery. It is essential to have the battery operational to maintain the Real Time Clock and Calendar information specifically during supply power down condition.

User can enable / disable battery low fault message.

Press ENTER key to edit option.

Press ▲ or ▼ key to get available options (Yes / No). Then press ENTER key to confirm newly changed option.

Bank Switching  
Count Warning.

BANK SWITCHING COUNT WARNING : -IF count crosses the set Capacitor switching count APFC gives warning only on display. If user resets the count that particular bank warning will disappear. By default warning is enabled.

Bank Health  
Warning.

BANK HEALTH WARNING : -The kvar value of the particular capacitor bank is calculated during each switching operation and compared with set bank value of capacitor. If the result is below the 80% of set bank value health warning will be displayed.

### **Section 11.4 : RESET VALUES :**

This menu allows user to reset one out of several parameters.

RESET VALUES

Press ENTER key to enter into reset values sub menus. Pressing ▲ or ▼ key will scroll through submenus.

RESET ENERGY

RESET ENERGY : Press ENTER key to reset all energy related parameters.

After resetting APFC will show "DONE" message on display.

RESET DEMAND

RESET DEMAND : Press ENTER key to reset all demand related parameters.

After resetting APFC will show "DONE" message on display.

RESET MIN PARA

RESET MINIMUM PARAMETERS : Pressing ENTER key will reset minimum voltage, current, frequency, temperature parameters.

After resetting APFC will show "DONE" message on display.

RESET MAX PARA

RESET MAXIMUM PARAMETERS : Pressing ENTER key will reset maximum voltage, current, frequency, temperature voltage THD, current THD, import power, export power, capacitive power, inductive power, apparent power parameters.

After resetting APFC will show "DONE" message on display.

RESET ON-RUN  
HOUR

RESET ON - RUN HOUR : Press ENTER key to reset run hour, on hour.

After resetting APFC will show "DONE" message on display.



---





RESET INTERRUPT

RESET INTERRUPT : Press ENTER key to reset power down interrupt count. After resetting APFC will show "DONE" message on display.

RESET BANK SWITCHING  
COUNT ( INDIVIDUAL / ALL )

RESET BANK SWITCHING COUNT : Press ENTER key to entered into submenus.. Then press  or  key get available options. Then pressed ENTER key to reset individual, all bank switching count. After resetting APFC will show "DONE" message on display.

RESET BANK OPERATION  
TIME ( INDIVIDUAL / ALL )

RESET BANK OPERATION TIME : Press ENTER key to entered into submenus.. Then press  or  key get available options. Then pressed ENTER key to reset individual, all bank operation count. After resetting APFC will show "DONE" message on display.

MODBUS SETUP

**Section 11.5 : MODBUS SETUP :**

This menu allows user to set modbus related setup.

Press ENTER key to enter into modbus setup sub menus.  
Pressing ▲ or ▼ key will scroll through submenus.

BAUD RATE

BAUD RATE : Press ENTER key to edit baud rate.

Press ▲ or ▼ key to get available options. Then pressing ENTER key will confirm newly changed values.  
Value are settable as 4.8k, 9.8k, 19.2k, 38.4k, 57.6kpbs.

PARITY

PARITY : Press ENTER key to edit parity.

Press ▲ or ▼ key to get available options. Then pressing ENTER key will confirm newly changed parity.  
parity are settable as none, even, odd.

STOP BITS

STOP BITS : Press ENTER key to edit stop bits.

Press ▲ or ▼ key to get available options. Then pressing ENTER key will confirm newly changed values.  
stop bits are settable as 1 or 2.

DEVICE ADDRESS

DEVICE ADDRESS : It allows to set RS 485 address for APFC.

Address are settable in range 1 to 247.

Press ENTER key to edit device address.

Pressing ▲ or ▼ key will increment or decrement digit value resp. Then pressing ENTER key will advance to next digit & confirm newly changed values.

## **Section 11.6 : DISPLAY SETUP :**

### DISPLAY SETUP

This menu allows user to set display related submenus.

Press ENTER key to enter into display setup sub menus.

Pressing ▲ or ▼ key will scroll through submenus.

### LCD BACKLIGHT

LCD BACKLIGHT : APFC allows to ON / OFF LCD

backlight. If backlight is set to off mode, APFC unit will switch off backlight after 30 Sec. During editing period backlight will get switch on & remained ON for next 30 Sec.

### AUTOSCROLL

AUTOSCROLL: APFC unit allows to enable / disable screen scrolling. Press ENTER key to edit autoscroll mode.

Press ▲ or ▼ key to get available options. Then pressing ENTER key will confirm newly changed autoscroll mode.

### CONTRAST

CONTRAST: APFC unit allows to set LCD contrast. It is settable in range 1 to 9.

Press ENTER key to edit LCD contrast.

Pressing ▲ or ▼ key will increment or decrement digit value. Then pressing ENTER key will advance to next digit & confirm newly changed contrast.

CHANGE PASSWORD

### **Section 11.7 :CHANGE PASSWORDS:**

To change Basic setting's password and Advanced setting's password enter correct password of Advanced Setting.

After entering Advanced Setting's correct password, APFC enters into advanced setting's sub-menus. Pressing ▲ or ▼ key will scroll through Advanced setting's sub-menus. Select "CHANGE PASSWORDS" sub-menu, Press ENTER key to enter into Change Password's sub menus. Pressing ▲ or ▼ key will scroll through Basic password, Advanced Password menu.

BASIC PASSWORD

### **BASIC PASSWORD:**

Press ENTER key to edit basic password.

Pressing ▲ or ▼ key will increment or decrement digit value. Then pressing ENTER key will advance to next digit & confirm newly changed password. To re-edit password, follow the same procedure as mentioned.

ADVANCE PASSWORD

### **ADVANCE PASSWORD:**

Press ENTER key to edit advanced password.

Pressing ▲ or ▼ key will increment or decrement digit value. Then pressing ENTER key will advance to next digit & confirm newly changed password. To re-edit password, follow the same procedure as mentioned.

**Section 12 : SERVICE MODE :**

Press ENTER key to entered into service sub menus.

Pressing ▲ or ▼ key will scroll through submenus.

The following sub menus will be available in service sub menus : -

1. V -MIN V-MAX
2. I -MIN I -MAX
3. Frequency- MIN MAX
4. Temperature Min MAX
5. Maximum V THD I THD
6. Maximum Import Power
7. Maximum Export Power
8. Maximum Capacitive power
9. Maximum Inductive power
10. Maximum Apparent power
11. Maximum Import demand
12. Maximum Export demand
13. Maximum Apparent demand
14. Maximum Ampere demand
15. C1 to C8\* Switching count
16. C1 to C8\* Operation time
17. C1 to C8\* Bank Kvar value
- 18 TEST RUN

For NF20 96 Model max relay as per configuration  
(max-8)

For NF20 144 Model max relay as per configuration  
(max-12)

### TEST RUN:

This menu point allows the user to check the settings of the NF20 controller. After activation of the test run, the controller switches each stage on and off successively and calculates the output of the capacitors connected (this procedure is done three times to eliminate possible errors). The values calculated are stored and can be retrieved in the following menu item (C-BANK kVar).

Any discrepancies in bank parameters found are evaluated and displayed in plain text. The following errors can be displayed:

- No Input voltage
- Under Voltage
- Over Voltage
- Check number of Banks
- Wrong power input

Note: The results displayed are messages intended to help the user trace the cause of the error. Final evaluation remains the responsibility of the user. Under complicated (high load fluctuations) grid conditions, 100% error recognition cannot be guaranteed.

### **Section 13 : TECHNICAL DATA :**

Display	<ul style="list-style-type: none"><li>- Large and multifunctional LCD (2 × 16 characters)</li><li>- Graphic and alphanumeric</li><li>- LCD illumination</li></ul>
System parameters displayed	<ul style="list-style-type: none"><li>- Line voltage (V AC)</li><li>- Reactive power (VAr)</li><li>- Active power (W)</li><li>- Frequency (Hz)</li><li>- Apparent power (VA)</li><li>- Line current (A)</li><li>- Temperature (°C)</li><li>- Real-time cos phi</li><li>- Diff to PF</li><li>- THD – V / THD - I in % upto 31st</li><li>- Individual Harmonics in % upto 31st for V &amp; I</li><li>- Energy kWh (Import/ Export)</li><li>- Energy kVAh</li><li>- Energy kVARh (Ind /Cap)</li><li>- Demand kVA/Current/kW (Imp / Exp)</li><li>- Run Hour</li><li>- On Hour</li><li>- No of interruption</li><li>- RTC time.</li><li>- System Fault 1/2.</li><li>- System Warning</li></ul>

Alarm output	<ul style="list-style-type: none"> <li>- Out of Bank (Under Compensation)</li> <li>- Overcompensation</li> <li>- Under Voltage</li> <li>- Over Voltage</li> <li>- Undercurrent</li> <li>- Overcurrent</li> <li>- Over temperature</li> <li>- Under / Over Frequency</li> <li>- Excess Harmonics ( V-THD / I-THD)</li> </ul>
Recall recorded values	<ul style="list-style-type: none"> <li>- Maximum / Minimum Voltage</li> <li>- Maximum / Minimum Current</li> <li>- Maximum / Minimum Frequency</li> <li>- Maximum Active Power (Import / Export)</li> <li>- Maximum Apparent Power</li> <li>- Maximum Capacitive Power</li> <li>- Maximum Inductive Power</li> <li>- Maximum Active Import Demand</li> <li>- Maximum Active Export Demand</li> <li>- Maximum Apparent Demand</li> <li>- Maximum Ampere Demand</li> <li>- Maximum / Minimum Temperature</li> <li>- Maximum THD(V/I)</li> <li>- Switching count of Capacitor</li> <li>- Operation time of capacitor</li> </ul>



Warning Messages	<ul style="list-style-type: none"> <li>- Capacitor switching count exceed the limit (OSC - Over Switching Count)</li> <li>- Capacitor kVAR value between 70 to 80% (CVAL)</li> <li>- Ambient temperature between 55 to 60 Degree Cel. (TMP)</li> <li>- RTC Battery Low (BAT) (Only applicable for RTC module)</li> </ul>
Weight	0.35 kg (96 model),0.5 kg ( 144 )
Nf20 96 Model	Panel-mounted 96 × 96 × 51 mm (Back Depth 75mm with add on module) (cut out 92 +0.8× 92+0.8 mm)
Nf20 144 Model	Panel-mounted 144×144×56 mm (cut out 138 × 138 mm)
Ambient conditions	
- Over-voltage class	III
- Pollution degree	2
- Operating temperature	-10 ... +60 °C
- Storage temperature	-20 ... +65 °C
- Sensitivity to EMC	IEC61326-1
- Safety guidelines	IEC 61010-1:2010
- Mounting position	Flush Mounting
- Humidity class	15% ... 95% non-condensing
Protection class	
- Front plate	IP54 to IEC60529
- Rear side	IP20 to IEC60529

<p>Operation</p> <ul style="list-style-type: none"> <li>- Auxiliary Supply voltage</li> <li>- Auxiliary Supply Frequency</li> <li>- Target cos phi</li> <li>- Switching On &amp; Off</li> <li>- Discharge Time</li> <li>Control modes</li> </ul>	<p>110 V AC – 550 V AC  40 to 70 Hz  0.8 ind. ... 0.8 cap.  10 s ... 30 min  60 s ... 30 min  self-optimized intelligent control mode</p>
<p>Measurement</p> <ul style="list-style-type: none"> <li>- Measurement voltage range</li> <li>- Fundamental frequency</li> <li>- Measurement current (CT)</li>   <li>- Minimum operating current</li> <li>- Maximum current</li> </ul> <p>Accuracy</p>	<p>30 ... 550 V AC (L-L / L-N)  50 / 60 Hz  x/5 and x/1 Ampere onsite programmable  2 mA  6 A (sinusoidal)  Current, voltage: 0.5% of nominal value  Active, Apparent, Reactive power: 1% of nominal value  Active Energy : 1%  Apparent Energy : 1%  Reactive Energy : 2%  THD : ± 4%</p>
<p>Switching outputs</p> <p>Relay outputs</p> <ul style="list-style-type: none"> <li>- Number of outputs</li> <li>- Switching voltage/Power</li> </ul>	<p>4 / 6 / 8 steps available (NF20 96 model)  6/ 8/12 steps available (NF20 144 model)  Max. 250 VAC / 1000W</p>
<p>Alarm relay</p>	<p>Potential-free contact (Max. 250 VAC / 1000W)</p>

**Section 14 : FACTORY DEFAULT SETTING :**

<b>Description</b>	<b>Default value</b>
System Nominal Voltage	240 VLN
CT Primary	1000 Amp
CT Seconadry	5 Amp
System frequency	50 Hz
System type	3 Phase
PHASE I (refer flow chart)	IL 1
PHASE V (refer flow chart)	VL 1 - N - 0°
Demand integration time	8 Min
Energy unit	kWh, KVArh, KVAh
Energy Rate	1 Min
Energy Overflow Count	8
Node address	1
RS485 setup code	9600, none, 2

**Section 14 : FACTORY DEFAULT SETTING :**

Basic Password	0000
Advanced Password	0001
Autoscroll	OFF
Backlite ON/OFF	ON
Contrast_level	5
Target power factor	0.995 IND
Banks in use	4 OR 6 OR 8 (As per add on card)
Maximum Switching Power	25 kVAr
Capacitor bank 1 kvar	25
Capacitor bank 2 kvar	25
Capacitor bank 3 kvar	25
Capacitor bank 4 kvar	25
Capacitor bank 5 kvar	25
Capacitor bank 6 kvar	25
Capacitor bank 7 kvar	25
Capacitor bank 8 kvar	25

<b>Description</b>	<b>Default value</b>
Bank switching Threshold	66%
Capacitor switch in time	40 Sec
Capacitor switch off time	40 Sec
Capacitor discharge time	60 Sec
Capcitor bank 1 (Auto/Fixed/Faulty)	Auto
Capcitor bank 2 (Auto/Fixed/Faulty)	Auto
Capcitor bank 3 (Auto/Fixed/Faulty)	Auto
Capcitor bank 4 (Auto/Fixed/Faulty)	Auto
Capcitor bank 5 (Auto/Fixed/Faulty)	Auto
Capcitor bank 6 (Auto/Fixed/Faulty)	Auto
Capcitor bank 7 (Auto/Fixed/Faulty)	Auto
Capcitor bank 8 (Auto/Fixed/Faulty)	Auto
C-health test (enable/disable)	Disable
Switch_operation_warning	50000
C Health test count	5

<b>Fault</b>	<b>Description</b>	<b>Default</b>
Under Voltage	Enable Parameter (*)	Enable
	Trip Value	85%
	Trip Delay (*)	5 Sec
	Hysteresis (*)	3%
	Relay	Yes
Over Voltage	Enable Parameter (*)	Enable
	Trip Value	110%
	Trip Delay (*)	5 Sec
	Hysteresis (*)	2%
	Relay	Yes
Under Frequency	Enable Parameter	Disable
	Trip Value	6%
	Trip Delay (*)	5 Sec
	Hysteresis (*)	1%
	Relay	No
Over Frequency	Enable Parameter	Disable
	Trip Value	6%
	Trip Delay (*)	5 Sec
	Hysteresis (*)	1%
	Relay	No

\*Note : - Parameters are not editable, Factory set.

<b>Fault</b>	<b>Description</b>	<b>Default</b>
Under Current	Enable Parameter (*)	Enable
	Trip Value	2%
	Trip Delay (*)	5 Sec
	Hysteresis (*)	1%
	Relay	Yes
Over Current	Enable Parameter (*)	Enable
	Trip Value	110%
	Trip Delay (*)	5 Sec
	Hysteresis (*)	1%
	Relay	Yes
V THD	Enable Parameter (*)	Enable
	Trip Value	7%
	Trip Delay (*)	30 Sec
	Hysteresis (*)	2%
	Relay	Yes
I THD	Enable Parameter (*)	Enable
	Trip Value	50%
	Trip Delay (*)	30 Sec
	Hysteresis (*)	45%
	Relay	Yes

\*Note : - Parameters are not editable, Factory set.

<b>Fault</b>	<b>Description</b>	<b>Default</b>
Temperature	Enable Parameter (*)	Enable
	Trip Value (*)	60 Degree
	Trip Delay (*)	10 Sec
	Hysteresis (*)	55 Degree
	Relay	Yes
Out Of bank	Enable Parameter (*)	Enable
	Trip Delay (*)	10 Sec
	Relay	Yes
OverCompensation	Enable Parameter (*)	Enable
	Trip Delay (*)	10 Sec
	Relay	Yes

\*Note : - Parameters are not editable, Factory set.



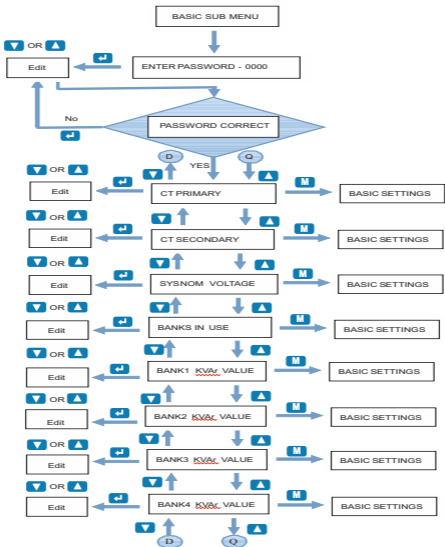

Note :- Depending on no. of banks configured Bank KVAR screen will shown upto that bank.

## **Section 15 : OPERATING DIAGRAM :**

**M** Menu Key

**↵** Enter Key

**▲** Up Key

**▼** Down Key

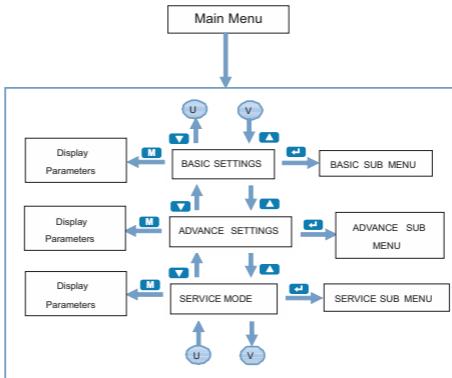

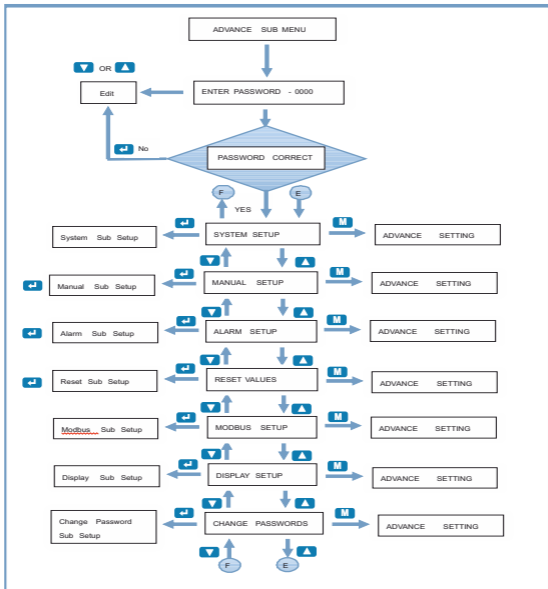

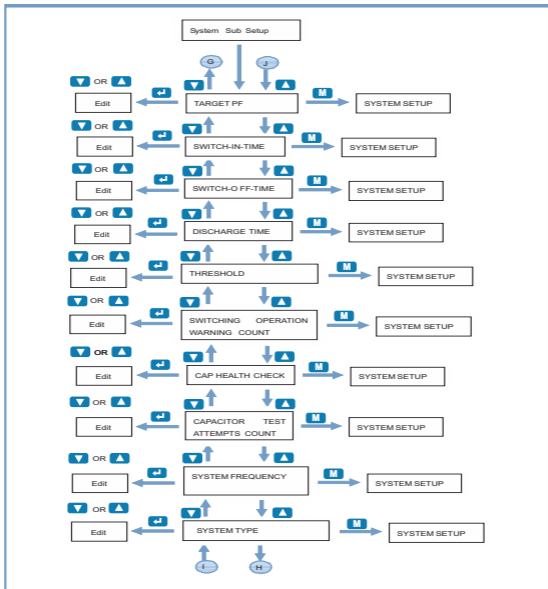

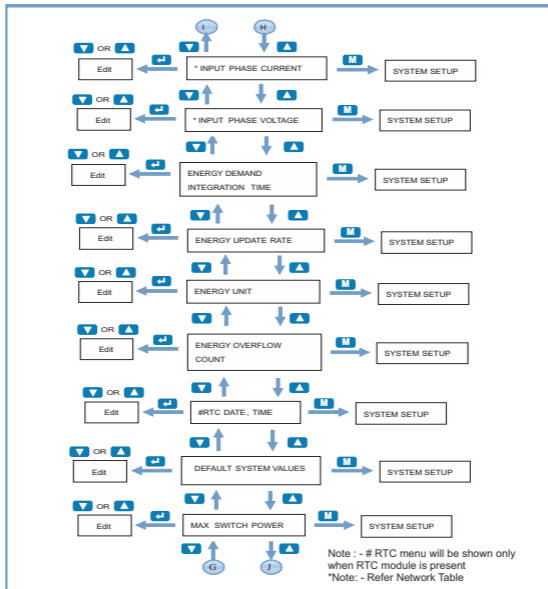

**Network Table :-**

PHASE CURRENT	PHASE VOLTAGE
IL1	L1 - N - $0^\circ$
IL1	L1 - L2 - $30^\circ$
IL1 ( k <-> l )	L2 - N - $60^\circ$
IL1	L3 - L2 - $90^\circ$
IL1	L3 - N - $120^\circ$
IL1	L3 - L1 - $150^\circ$
II1 ( k <-> l )	L1 - N - $180^\circ$
II1 ( k <-> l )	L1 - L2 - $210^\circ$
IL1	L1 - N - $240^\circ$
II1 ( k <-> l )	L2 - L3 - $270^\circ$
II1 ( k <-> l )	L3 - N - $300^\circ$
II1 ( k <-> l )	L3 - L1 - $330^\circ$

PHASE CURRENT	PHASE VOLTAGE
IL2	L2 - N - $0^\circ$
IL2	L2 - L3 - $30^\circ$
IL2 ( k <-> l )	L3 - N - $60^\circ$
IL2	L1 - L3 - $90^\circ$
IL2	L1 - N - $120^\circ$
IL2	L1 - L2 - $150^\circ$
IL2 ( k <-> l )	L2 - N - $180^\circ$
II2 ( k <-> l )	L2 - L3 - $210^\circ$
IL2	L3 - N - $240^\circ$
IL2 ( k <-> l )	L3 - L1 - $270^\circ$
II2 ( k <-> l )	L1 - N - $300^\circ$
II2 ( k <-> l )	L1 - L2 - $330^\circ$

PHASE CURRENT	PHASE VOLTAGE
IL3	L3 - N - $0^\circ$
IL3	L3 - L1 - $30^\circ$
II3 ( k <- > I )	L1 - N - $60^\circ$
IL3	L2 - L1 - $90^\circ$
IL3	L2 - N - $120^\circ$
IL3	L2 - L3 - $150^\circ$
II3 ( k <- > I )	L3 - N - $180^\circ$
II3 ( k <- > I )	L3 - L1 - $210^\circ$
IL3	L1 - N - $240^\circ$
II3 ( k <- > I )	L1 - L2 - $270^\circ$
II3 ( k <- > I )	L2 - N - $300^\circ$
II3 ( k <- > I )	L2 - L3 - $330^\circ$

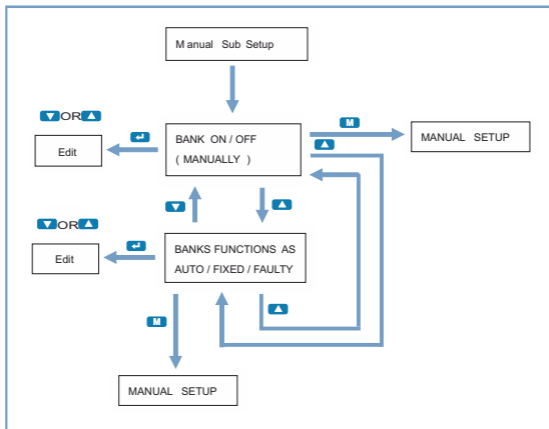



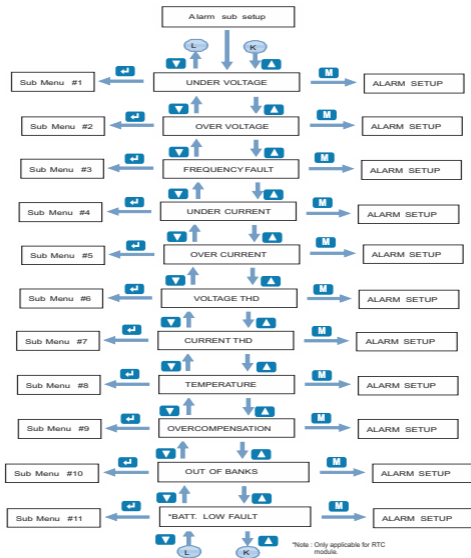

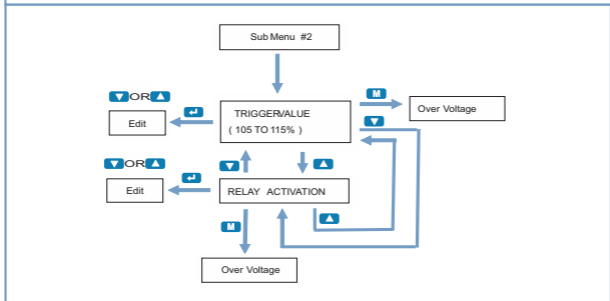
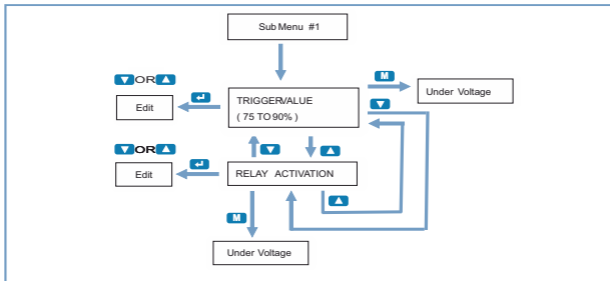

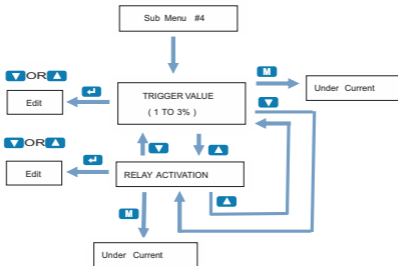
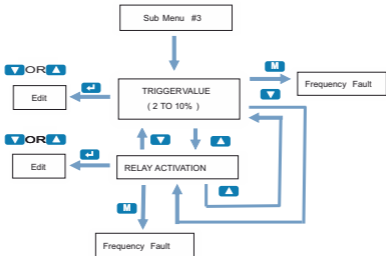

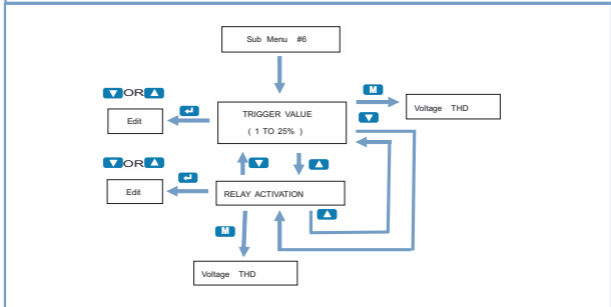
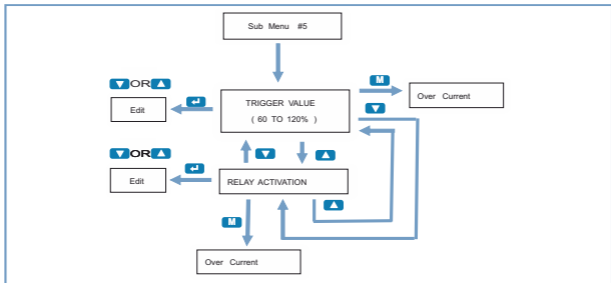

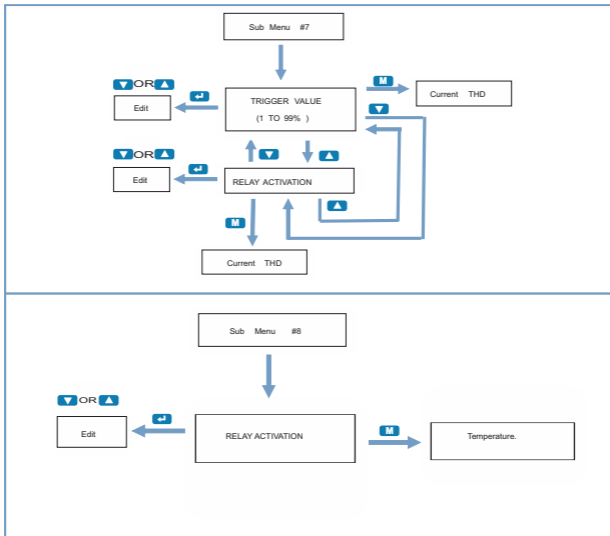

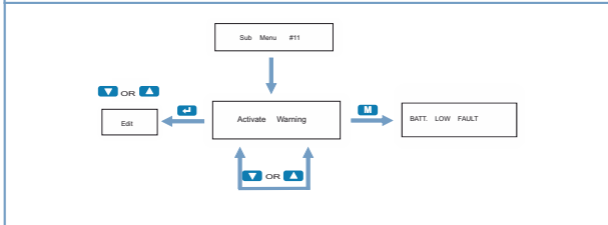
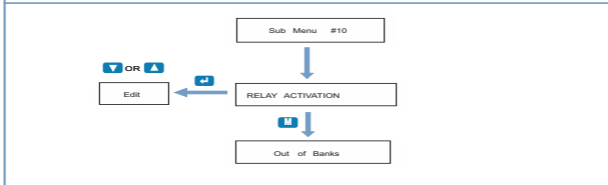
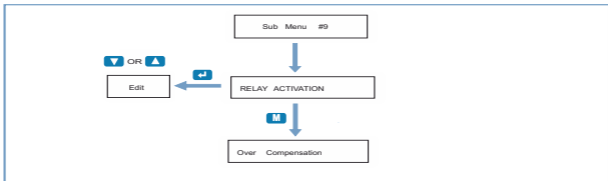

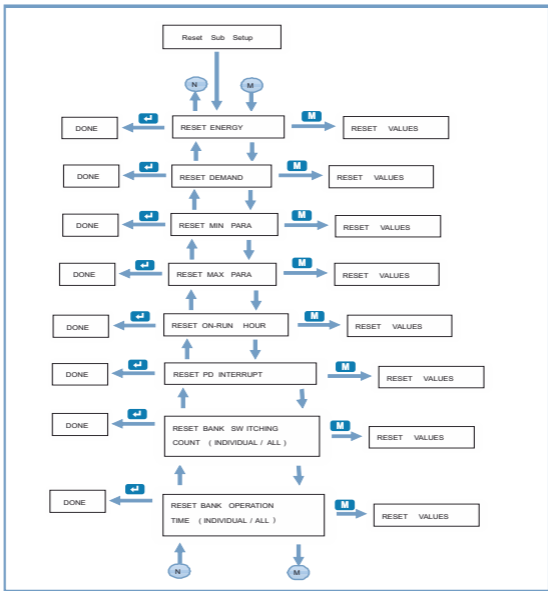

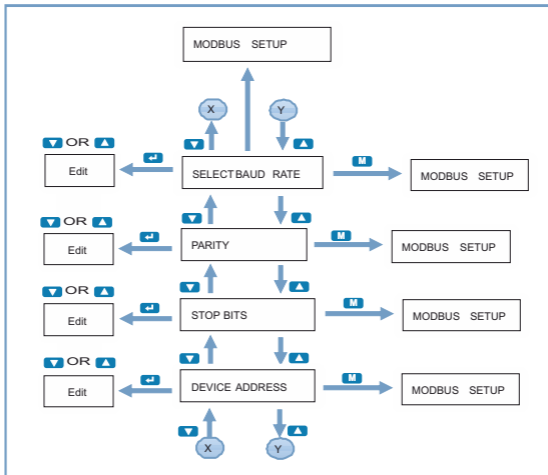



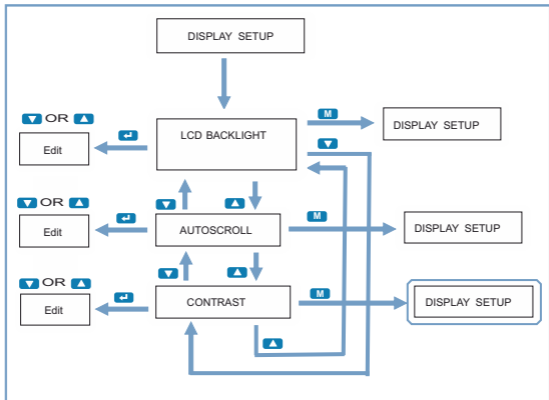

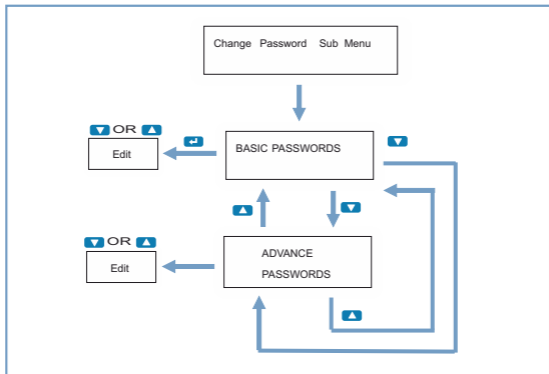

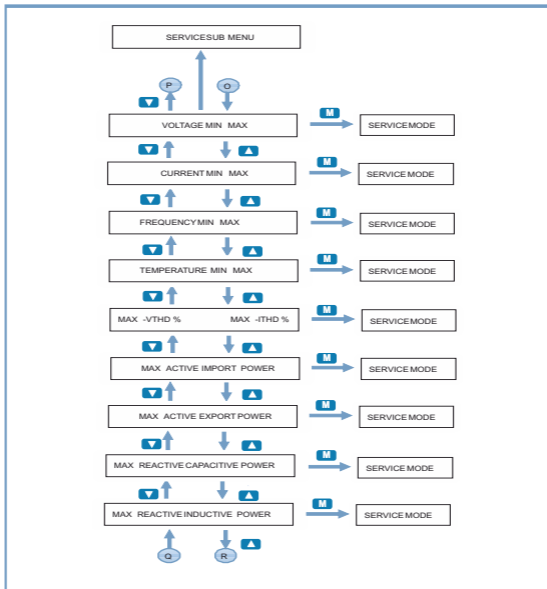

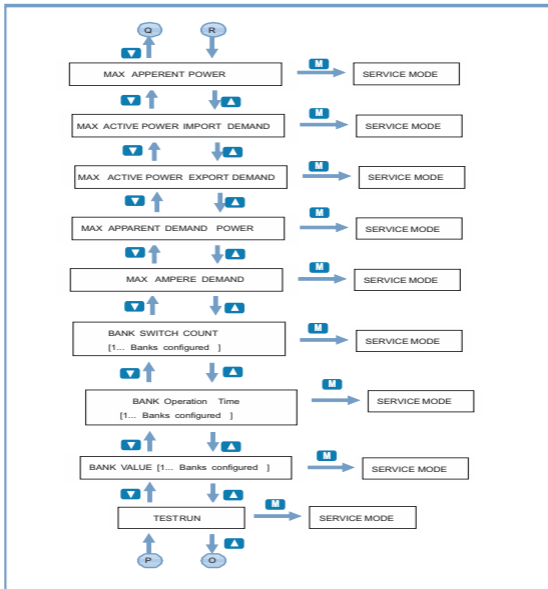

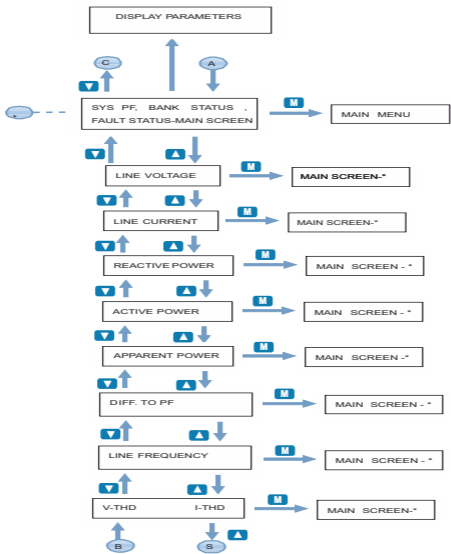

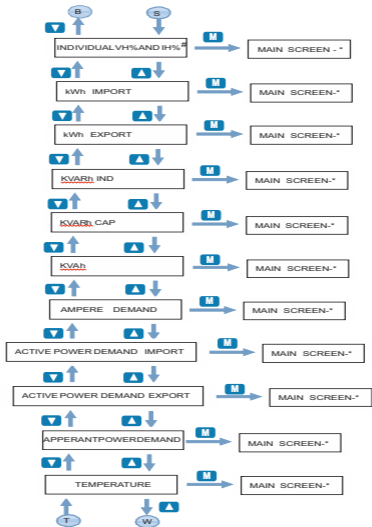

#Note : - Enter key at individual harmonics screen then press **▼** OR **▲** key to get next individual harmonics count.

## Power Factor Controller

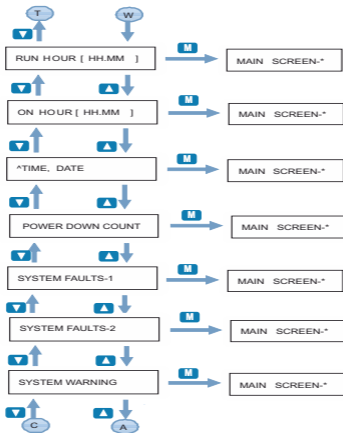

\*Note : - Only applicable for RTC module.

## Section16 Ordering codes

Power factor controller NF20	A	1	H	X	X	X	X	X	X	000	X	X
<b>Size:</b>												
96 x 96	A											
<b>Input voltage:</b>												
240V; 50/60Hz		1										
<b>Power supply:</b>												
110-550VAC			H									
<b>Relay output:</b>												
4 Relay O/P											4	
6 Relay O/P <sup>1</sup>												6
8 Relay O/P												8
<b>Alarm output:</b>												
With Alarm Output												A
<b>RS-485 modbus:</b>												
With RS-485 <sup>2</sup>												R
Without RS-485												Z
<b>Real Time Clock (RTC):</b>												
With RTC												R
Without RTC												Z
<b>Adaptor plate:</b>												
Without Adaptor Plate												0
With Adaptor Plate												1
<b>Version:</b>												
Standard												000
<b>Language:</b>												
Polish												P
English												E
<b>Acceptance tests:</b>												
without additional quality requirements												0
with an extra quality inspection certificate												1
with a calibration certificate												2

controller execution 96x96 mm



<sup>1</sup> Limited availability, needs to be agreed with the manufacturer

<sup>2</sup> Interface RS-485 available only for the controller with 8 relay outputs



Power factor controller NF20	B	1	H	X	A	X	X	0	000	X	X
<b>Size:</b>											
144 x 144	B										
<b>Input voltage:</b>											
240V; 50/60Hz	1										
<b>Power supply:</b>											
110-550VAC	H										
<b>Relay output:</b>											
6 Relay O/P				6							
8 Relay O/P <sup>1</sup>				8							
12 Relay O/P				A							
<b>Alarm output:</b>											
With Alarm Output				A							
<b>RS-485 Modbus:</b>											
With RS-485 <sup>2</sup>					R						
Without RS-485					Z						
<b>Real Time Clock (RTC):</b>											
With RTC						R					
Without RTC						Z					
<b>Adaptor plate:</b>											
Without Adaptor Plate							0				
<b>Version:</b>											
Standard								000			
<b>Language:</b>											
Polish										P	
English										E	
<b>Acceptance tests:</b>											
without additional quality requirements											0
with an extra quality inspection certificate											1
with a calibration certificate											2

controller execution 144x144 mm











**LUMEL S.A.**

ul. Sulechowska 1, 65-022 Zielona Góra, Poland  
tel.: +48 68 45 75 100, fax +48 68 45 75 508  
[www.lumel.com.pl](http://www.lumel.com.pl)

**Export department:**

tel.: (+48 68) 45 75 139, 45 75 233, 45 75 321, 45 75 386  
fax.: (+48 68) 32 54 091  
e-mail: [export@lumel.com.pl](mailto:export@lumel.com.pl)